

RoHS Compliant

REVISIONS			
REV.	DESCRIPTION	DATE	DESIGN

NOTES:

SPECIFICATION:

- CURRENT RATING: 3.0A MAX
- DIELECTRIC WITHSTAND VOLTAGE: 100VAC
- TEMPERATURE RANGE: -30 °C ~ 85 °C
- CONTACT RESISTANCE: 40 MILLIONHM MAX
- INSULATION RESISTANCE: 100 MEGOHMS MIN.
- INSERTION FORCE :10N~30N
- UNMATING FORCE: 8N~30N
- DURABILITY:1500 CYCLES

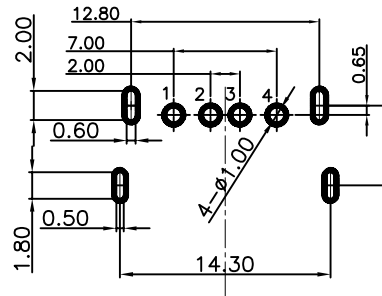
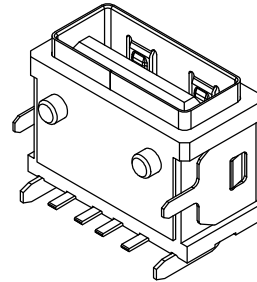
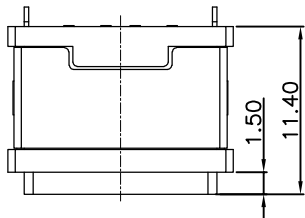

RECOMMENDED PCB LAYOUT(TOP VIEW)

THICKNESS T=1.0mm  
 DEFAULT TOLERANCE+/-0.05  
 PCB板设计需修改LAYOUT时, 请知会厂商修改检验孔规

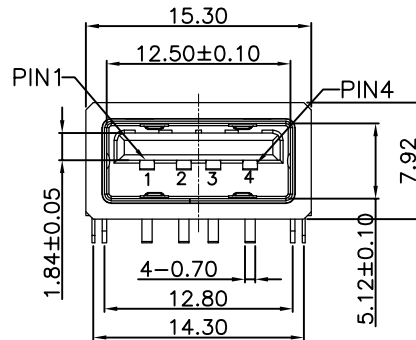
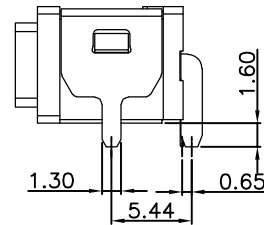

PART NO. INFORMATION

U01-A F X X 5 R - W001-V2

- PORT TYPE: A: TYPE A
- GENDER: F: FEMALE, M: MALE
- CONTACT PLATED: 1: GOLD FLASH, 2: GOLD 3U'', 3: GOLD 5U'', 4: GOLD 10U'', 5: GOLD 15U'', 6: GOLD 30U''
- PACKAGE: R: TAPE REEL T: TRAY
- HOUSING COLOR: 2: WHITE, 5: BLACK, 9: NATURE
- HOUSING MATERIAL: A: LCP, B: PBT, C: PA9T, D: PA6T, E: PA46, F: PA66, G: PA10T

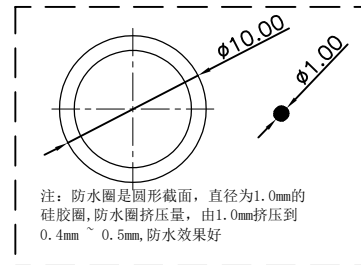
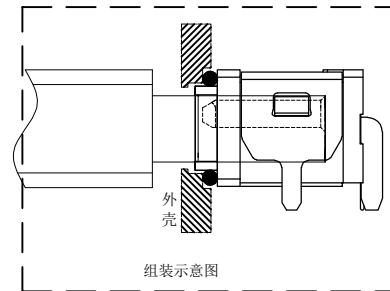

结构设计注意:

- 成品使用时, 如有洗面奶泡沫、牙膏、洗手液、脏污液体, 请在USB口外面再设计一层外壳, 保护USB与公头对插的导电部份不会被脏污覆盖。

PIN ASSIGNMENT

PIN NO.	1	2	3	4
SINGAL NAME	VBUS	D-	D+	GND

5	Outer Shell	1	SUS 301 1/4H	
4	Inner Shell	1	SUS 301 1/4H	
3	PLASTIC Shell	1	PA10T (G.F30%)	
2	Contact	4	C7025 Ni 50U'' Au1U'' Plating Solder area Sn 100-150U''	
1	Housing	1	PA10T (G.F30%)	
ITEM	PART NAME	Q' TY	FINISH	NOTE

**Bestcreate Technology Limited**

TOLERANCES UNLESS OTHERWISE SPECIFIED:  
 X. ± 0.50 X.\* ± 2'  
 .X ± 0.30 .X.\* ± 1'  
 .XX ± 0.10 .XX.\* ± 0.5'  
 Website:www.bsc-elec.com  
 Email:bestcreate@bsc-elec.com

DESIGN: DATE:  
 I.L 2017.3.1  
 CHECKED: DATE:  
 C.W 2017.3.1  
 APPROVED: DATE:  
 C.W 2017.3.1

TITLE: IPX7 WATERPROOF USB 2.0 A FEMALE 4P CONNECTOR DIP TYPE  
 MATERILA: PART NO: U01-AFXX5R-W001-V2 SIZE: A4  
 FINSH: DWG NO: U01-AFXX5R-W001-V2 1 OF 1

REV: A UNIT mm SCALE 1=1 QUALITY SYMBOLS