

RoHS Compliant

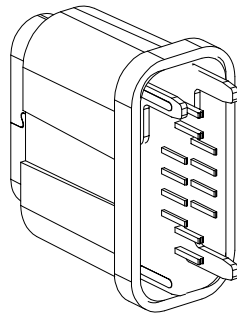
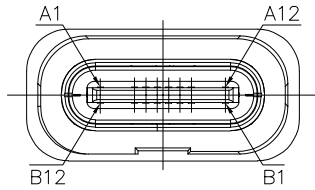

REVISIONS			
REV.	DESCRIPTION	DATE	DESIGN

备注:

1. 材质:
  - 1.1 胶芯: LCP+30%G.F UL94V-0
  - 1.2 端子: C7025 : 镍底50U" MIN  
接触区域镀金 (AU 1u") 焊接区域镀金G/F
- 1.3 外壳: SUS304, T=0.30mm: 表面镀镍30U" MIN
- 1.4 中夹片: SUS301:
2. 主要特性:
  - 2.1 额定电流: 5A
  - 2.2 接触阻抗: 40mΩ MAX (初始值)  
50mΩ MAX (测试后)
  - 2.3 绝缘阻抗: 100MΩ MIN
  - 2.4 耐压测试: 100V AC R M S
  - 2.5 整体插入力: 5-20N 整体拔出力: 5-20N (耐久后)  
整体拔出力: 8-20N 整体拔出力: 6-20N (耐久后)
  - 2.6 耐久: 10000次
  - 2.7 耐高温: SMT回流焊 (峰值260° ±5°), 塑胶不能有起泡, 融胶等不良, 变色, 翘曲变形在公差范围以内。
  - 2.8 产品须做焊锡测试, 粘锡面积达到95%以上;
  - 2.9 盐雾测试: 24H MIN
  - 3.0 工作温度: -25°C ~ +80°C

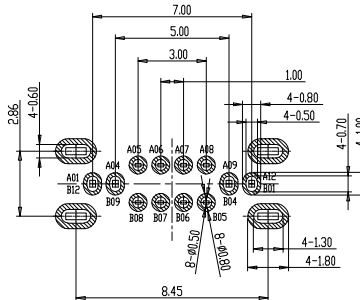
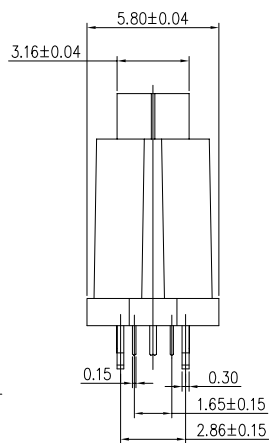
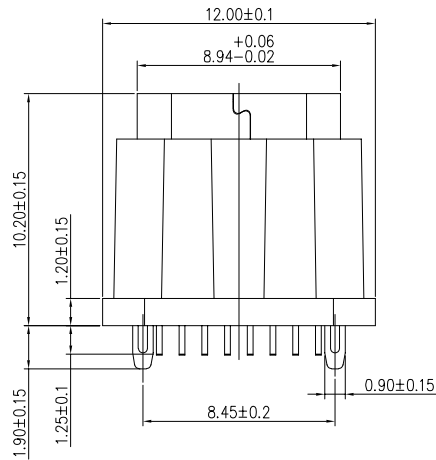

RECOMMENDED P.C.B. LAYOUT (俯视图)  
TOLERANCE UNSPECIFIED ±0.05mm

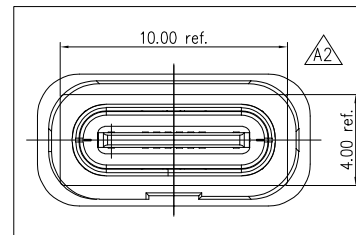

吸附盖参考尺寸

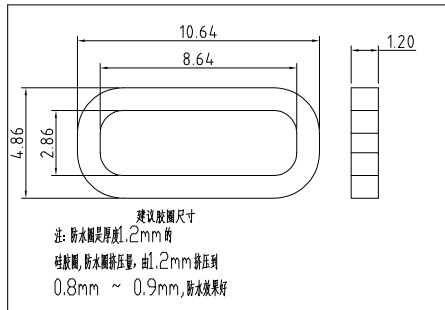

USB TYPE-C PIN ASSIGNMENTS

PIN NUMBER	SIGNAL NAME	PIN NUMBER	SIGNAL NAME
A1	GND	B12	GND
A4	VBUS	B9	VBUS
A5	CC1	B8	SBU2
A6	Dp1	B7	Dn2
A7	Dn1	B6	Dp2
A8	SBU1	B5	CC2
A9	VBUS	B4	VBUS
A12	GND	B1	GND

PART NO. INFORMATION

U06-C F X X 5 R - W182 - V2

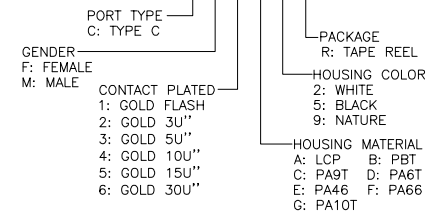

Bestcreate Technology Limited

TOLERANCES UNLESS OTHERWISE SPECIFIED:

X.	± 0.38	X.*	± 5'
.XX	± 0.30	.X'	± 3'
.XXX	± 0.20	.XX'	± 1'

Website: www.bsc-elec.com  
Email: bestcreate@bsc-elec.com

DESIGN: I.L DATE: 2018.7.7

CHECKED: C.W DATE: 2018.7.7

APPROVED: C.W DATE: 2018.7.7

TITLE: IP67 16P WATERPROOF USB C FEMALE CONNECTOR VERTICAL DIP,H10.2

MATERIAL:	PART NO:	SIZE:
FINSH:	U06-CFXX5R-W182-V2	A4
	DWG NO: U06-CFXX5R-W182-V2	1 OF 1

REV:	UNIT	SCALE	QUALITY SYMBOLS
A	mm	1=1	