

RoHS Compliant

REVISIONS			
REV.	DESCRIPTION	DATE	DESIGN

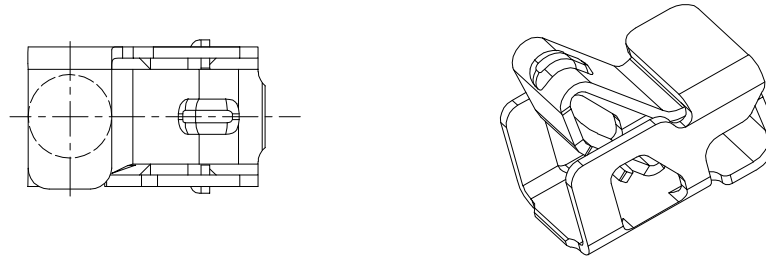

- 1.MATERIAL SPECIFICATION:
 1.1.STAINLESS STEEL SUS-301 T=0.08±0.005MM
 2.TEST REQUIREMENTS:
 2.1.CONTACT RESISTANCE: 80mΩ MAX
 2.2.VOLTAGE RATING: 1.5 V/AC/DC/MAX
 2.3.RATED CURRENT: 1.0A/MAX
 2.4.WELDING THRUST: ≥3.0 Kg
 2.5.DURABILITY: 1,500 TIMES
 2.6.OPERATING TEMPERATURE: -20 ° ~ 80 ° C
 3.PLATING REQUIREMENTS:
 3.1.OVERALL NICKEL PLATING 50U MIN, WELDING SURFACE 1U MIN GOLD PLATING, CONTACT AREA 1U MIN GOLD PLATING
 3.2.SALT SPRAY TEST TO MEET THE REQUIREMENTS OF 24 HOURS.
 3.3.TERMINAL TO EAT FULL TIN, NOT PEELING, WELDING, OBVIOUS COLOR AND OTHER ADVERSE
 3.4.ROHS, REACH, HF HALOGEN-FREE AND A SERIES OF DOMESTIC AND INTERNATIONAL ENVIRONMENTAL REQUIREMENTS

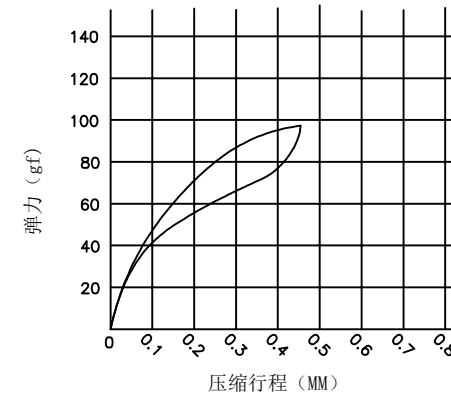
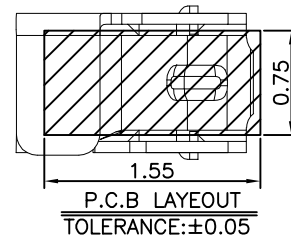
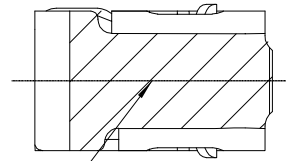
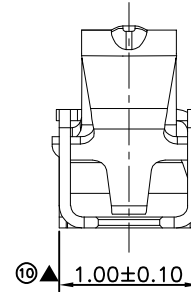
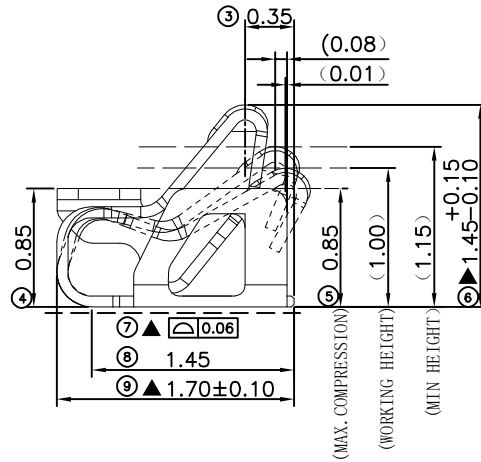
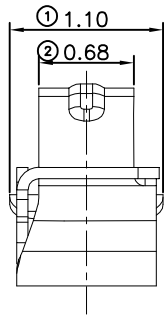

Bestcreate Technology Limited

TOLERANCES UNLESS OTHERWISE SPECIFIED:

X.	± 0.25	X.*	± 3'
.X	± 0.20	.X'	± 2'
.XX	± 0.15	.XX'	± 1'

Website:www.bsc-elec.com
 Email:bestcreate@bsc-elec.com

DESIGN: I.L
 DATE: 2017.3.1

CHECKED: C.W
 DATE: 2017.3.1

APPROVED: C.W
 DATE: 2017.3.1

TITLE: Antenna Shrapnel Connector
 1.7*1.00*1.45H(D TYPE)

MATERIAL: AS-R5-098-0014D
 PART NO: AS-R5-098-0014D
 SIZE: A4

FINISH: AS-R5-098-0014D
 DWG NO: AS-R5-098-0014D

REV: A
 UNIT: mm
 SCALE: 1=1
 QUALITY SYMBOLS

